

Article number: 2302084221

Description: E+G Lock knob  
VTR.60 FP-M10

## Measures

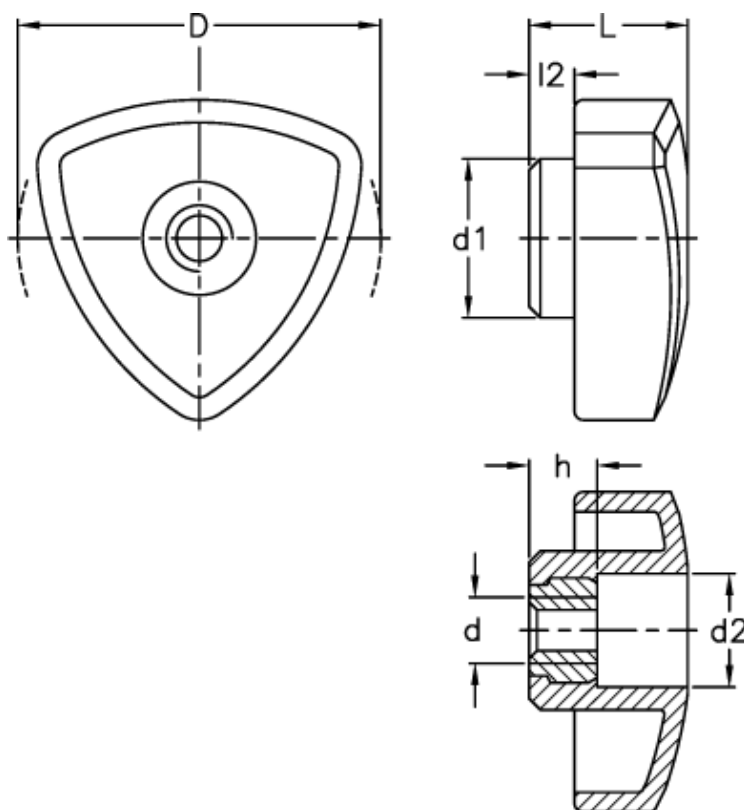

$d$	= 60
$d_1$	= 22
$d_2$	= 19
$d\ 6H$	= M10
$h$	= 12
$L$	= 26
$l_2$	= 7